

Operating instructions

Hole-detection instruments
Type series PP2445

E_435x2

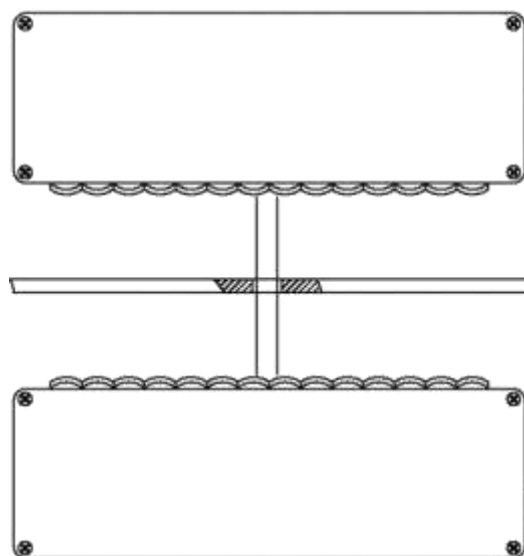

Characteristic features

- ✓ Application 1: Hole-marked weld seam or basted-seam detection
- ✓ Application 2: Pin-hole analysis in sheet metal inspection lines
- ✓ Excellent optical performance – reliable detection of the smallest holes
- ✓ Extensive ranges – up to 4 m with consistent monitoring width
- ✓ Robust design – especially developed for the steel processing industry
- ✓ Wide availability – also with dust and dirt
- ✓ Response time characteristics
 - Standard 12 ms
 - Quick 'q' 1,5 ms
 - Super quick 'qq' 0,5 ms
- ✓ Extensive operating temperature range -25°C to +60°C

Table of contents

1	Identification	4
1.1	<i>Manufacturer</i>	4
1.2	<i>Applied standards and technical specifications</i>	4
1.3	<i>Product types</i>	4
2	Intended use	5
2.1	<i>Purpose of the application of a hole detection instrument</i>	5
2.1.1	<i>Application for hole-marked weld or basted-seam detection</i>	5
2.1.2	<i>Application for pin-hole detection</i>	5
2.2	<i>Basic construction and function of hole detection instruments of the type series PP2445</i>	6
2.3	<i>Hole-marked welded / basted seam detection with hole detection instruments of the type series PP2445</i>	6
2.4	<i>Imperfection detector – pin-hole detector – with a hole detection instrument or a combination of hole detection instruments of the type series PP2445</i>	7
2.4.1	<i>Imperfections – larger than or the same as 3 mm</i>	7
2.4.2	<i>Imperfections – much smaller than 2 mm</i>	7
2.5	<i>Safety instructions</i>	8
3	Operating instructions	9
3.1	<i>System configurations</i>	9
3.1.1	<i>Overall view 3 part configuration</i>	9
3.1.2	<i>Overall view 4 part configuration</i>	9
3.2	<i>Operating principle</i>	9
3.3	<i>Response behaviour</i>	10
3.4	<i>Response time characteristics</i>	11
3.5	<i>Determination of the necessary response time characteristic for a specific case of application</i>	12
3.6	<i>Monitoring widths of hole detection instruments</i>	12
3.6.1	<i>Determination of the monitoring width for a hole-detection instrument to find a hole marked welded /basted seam.</i>	13
3.6.2	<i>Determination of the monitoring width for a hole detection instrument for finding imperfections</i>	13
3.7	<i>Installation recommendations and presettings</i>	14
3.7.1	<i>General arrangement</i>	14
3.7.2	<i>Installation arrangement</i>	14
3.7.3	<i>Side floor assembly – from inside</i>	15
3.7.4	<i>Side floor assembly – from outside</i>	15
3.7.5	<i>Rear panel assembly – from outside</i>	15



3.8 *Electric connection* 16

3.8.1 *General information / prerequisites* 16

3.8.2 *Connection with connector ‘stLU5’* 17

3.8.3 *Supply and output cable transmitter* 17

3.8.4 *Connector cable transmitter ↔ receiver* 18

3.8.5 *Connector cable transmitter ↔ power supply and control device (optional)* 18

3.8.6 *Connection with a terminal block (optional power supply and control device)* 19

3.8.6.1 *AC variants – instrument types and option identifications* 19

3.8.6.2 *DC-Variants – instrument types and option identifications* 21

3.9 *Operator control and indicating elements (overall view)* 21

3.9.1 *Transmitter and receiver unit* 21

3.9.1 *Power supply and control device (optional)* 22

3.10 *Operating mode switch, switch display and switching output* 23

3.11 *Adjustment of the switching pulse prolongation* 24

3.11.1 *Pulse prolongation at the bright switching output* 24

3.11.2 *Pulse prolongation at the dark switching output* 24

3.12 *Avoiding optical disturbances* 25

4 Technical data **25**

4.1 *Generally* 25

4.2 *Transmitter units* 26

4.3 *Receiver units* 27

4.4 *Power supply and control devices* 28

5 Dimensions **29**

5.1 *Hole detection instruments with monitoring width of 88 mm to 220 mm* 29

5.2 *Hole detection instruments with monitoring width 308 mm* 30

5.3 *Hole detection instruments with application specific monitoring widths larger than 308 mm to 1980 mm* 30

5.4 *Power supply and control device* 31

6 Document collection **31**

7 Maintenance and cleaning **32**

8 Taking out of service **32**

9 Spare parts **32**

1 Identification

1.1 Manufacturer

Fotoelektrik Pauly GmbH

Wahrbrink 6
59368 Werne
Germany

1.2 Applied standards and technical specifications

2014/35/EU	Low Voltage Directive	2014-02-26
2014/30/EU	Directive relating to electromagnetic compatibility	2014-02-26
DIN EN 60947-5-2	Low-Voltage Switchgear and Control-gear, Part 5-2 Control circuit devices and switching elements – Proximity switches	2014-01

1.3 Product types

Type	Equipment	Type of equipment	Group-No.
PP2445/88	PP2445/88S	Transmitter	4351Sx01
	PP2445/88E	Receiver	4351Ex01
PP2445/88 ...q	PP2445/88S ...q	Transmitter	4351Sx02
	PP2445/88E ...q	Receiver	4351Ex02
PP2445/88 ...qq	PP2445/88S ...qq	Transmitter	4351Sx03
	PP2445/88E ...qq	Receiver	4351Ex03
PP2445/154	PP2445/154S	Transmitter	4352Sx01
	PP2445/154E	Receiver	4352Ex01
PP2445/154 ...q	PP2445/154S ...q	Transmitter	4352Sx02
	PP2445/154E ...q	Receiver	4352Ex02
PP2445/154 ...qq	PP2445/154S ...qq	Transmitter	4352Sx03
	PP2445/154E ...qq	Receiver	4352Ex03
PP2445/220	PP2445/220S	Transmitter	4353Sx01
	PP2445/220E	Receiver	4353Ex01
PP2445/220 ...q	PP2445/220S ...q	Transmitter	4353Sx02
	PP2445/220E ...q	Receiver	4353Ex02
PP2445/220 ...qq	PP2445/220S ...qq	Transmitter	4353Sx03
	PP2445/220E ...qq	Receiver	4353Ex03
PP2445/308	PP2445/308S	Transmitter	4354Sx01
	PP2445/308E	Receiver	4354Ex01
PP2445/308 ...q	PP2445/308S ...q	Transmitter	4354Sx02
	PP2445/308E ...q	Receiver	4354Ex02
PP2445/308 ...qq	PP2445/308S ...qq	Transmitter	4354Sx03
	PP2445/308E ...qq	Receiver	4354Ex03

Type	Equipment	Type of equipment	Group-No.
PP2445/H (H ≥ 330)	PP2445/HS	Transmitter	4355Sx01
	PP2445/HE	Receiver	4355Ex01
PP2445/H ...q (H ≥ 330)	PP2445/HS ...q	Transmitter	4355Sx02
	PP2445/HE ...q	Receiver	4355Ex02
PP2445/H ...qq (H ≥ 330)	PP2445/HS ...qq	Transmitter	4355Sx03
	PP2445/HE ...qq	Receiver	4355Ex03
PP83201/2	PP83201/2	Power supply unit	2420x...
PP84201/2	PP84201/2	Power supply unit	2433x...
PP85301	PP85301	Power supply unit	2431x...
PP86301	PP86301	Power supply unit	2436x...

2 Intended use

These operating instructions contain important information about the intended use. It is included in the delivery scope and should always be read carefully before using the hole-detection instruments and components of the type series PP2445.

Knowledge of the contents of these operating instructions are part of the intended use. Advice and safety instructions must be observed in particular.

2.1 Purpose of the application of a hole detection instrument

A hole-detection instrument is used to typically inspect steel strips and other metal sheets for any light transmission.

2.1.1 Application for hole-marked weld or basted-seam detection

A hole is deliberately punched for the weld or basted-seam detection, and thus a light transmission is forced. The hole is typically punched under consideration of the strip dimensions, stamping precision and strip flow tolerances in a certain area before the weld seam. Finding a hole is then always connected with the fact that a weld seam follows after a hole at a specific distance.

It has to be observed in this procedure that also other light transmission imperfections like a welded seam marking can be read. Process disturbances are thus to be intercepted by appropriate software aided plausibility checks. E.g. the probable place of a welded/ basted seam can be predicted on the basis of drive data. Then with this prediction, the evaluation of the hole-detection instrument can be carried out within an appropriate time frame.

2.1.2 Application for pin-hole detection

An imperfection detection in a sheet inspection line is to prove that there are no places pervious to light – pin-holes – in a sheet. Pin-holes can have a negative impact on later strip processing processes. Imperfections can occur during the sheet production in rolling, drawing and quenching and tempering. Imperfections occur by chance and are not conditioned by place and time. That is why the attempt is made in a sheet inspection line to inspect the entire area of a sheet for light transmission.

2.2 Basic construction and function of hole detection instruments of the type series PP2445

Hole-detection instruments of the type series PP2445 consist of a transmitter unit, a receiver unit and an electric connector cables. A power supply and control device is available as an external additional component.

It is important for all model variations that the lens surfaces of the transmitter and receiver units directly face each other in the working mode.

The lens surfaces for the transmitter and receiver unit of a hole-detection instrument are produced by lining up square lenses. The individual square lenses have an edge length of approximately 22 mm. The monitoring width for a hole-detection instrument thus ensues from the total width of adjacent lenses. Monitoring widths of 88 mm to 1,980 are possible.

In the hole-detector mode, the entire monitoring width of a hole-detection instrument is taken up by the strip to be inspected. As soon as a place pervious to light in the strip passes the monitoring area of the hole-detection instrument, a switch signal shows up this event.

In general cases, holes with a diameter of 2 mm and even in the distance of 4 m between transmitter and receiver can be recognised. This recognition also functions with top strip speeds.

With special alignments of hole detection instruments, even holes with diameters of $\leq 0,5$ mm are detectable.

2.3 Hole-marked welded / basted seam detection with hole detection instruments of the type series PP2445

Endless strips are typically produced in sheet production plants. Here sheets are connected with each other by a welded or basted seam. This connecting seam has to be recognised at the various process points in a sheet production plant.

Thus every connecting seam is marked with a hole. For this, a hole is punched in the sheet at a defined position before the connecting seam. With a hole-detection instrument of the type series PP2445, this hole is sought within the specific monitoring width of the device. Then the hole-detection instrument gives off a switch signal if a hole is detected.

The necessary monitoring width for a hole-detection instrument depends on the strip dimensions, the positioning precision of the punched hole and the side strip run movement tolerances. For a sure detection of the marked hole, the marked hole has to be run through the monitoring area.

Hole detection instruments with 3 different response time characteristics (standard, 'q' and 'qq') are available for the various applications. The necessary response time characteristics are determined by shape and size of the marked hole as well as according to the actual strip speed at the installation place of the hole-detection instrument. The diagram 'Hole-size versus strip speed' (in chapter 3.4) helps to correctly determine the necessary response time characteristic for a certain pairing of hole-size and strip speed.

2.4 Imperfection detector – pin-hole detector – with a hole detection instrument or a combination of hole detection instruments of the type series PP2445

The impressive optical performance of the hole-detection instruments from the type series PP2445 is also suitable for seeking imperfections in sheet inspection lines.

Hole-detector instruments with application specific monitoring widths can be manufactured for this purpose. The monitoring widths and the response time characteristics for a hole-detection instrument are here to be aligned to the sheet dimensions, the size of the possible imperfections and the side strip movement tolerances.

2.4.1 Imperfections – larger than or the same as 3 mm

To detect imperfections larger than 2 mm, a hole-detection instrument with appropriated monitoring width or a cascade of individual hole-detection instruments arranged next to each other is suitable. The monitoring width is to be selected in such a way, so that considering the side strip movement tolerances, the monitoring area cannot pass the outer edge of the strip.

The combination of side strip movement tolerance and selected monitoring width results in the actually inspected area of the strip.

The necessary response characteristic depends on the strip speed.

2.4.2 Imperfections – much smaller than 2 mm





The detection of imperfections – smaller than 2 mm – is possible due to an alignment of two stand-alone transmitter and receiver units in the movement direction of the strip aligned one behind the other.

Moving the two transmitter receiver units by half a lens grid also causes the very smallest imperfection holes to be run through at least one lens grid with high performance. Thus the smallest holes are detected by either both hole-detection instruments, at least however by one.

By the combinatorial evaluation of both hole detection instruments, imperfections with hole sizes very much smaller than 2 mm can thus be found, and this even with high strip speeds and long light path distances.

The necessary response time characteristics are based on the strip speed.

2.5 Safety instructions

-  The operator/constructor has to inform himself about the provisions in force for his area of application and observe these, this also applies to the installation and laying of the cables and leads to be carried out.
-  Installation and connection work on the components of the hole-detection instruments type series PP2445 and the appropriate power supply devices may only be carried out in switched off condition.
-  Maintenance work may only be carried out by qualified electricians.
-  The device must be taken out of operation in the event of damage or leaks in the housing, in the plug connectors or in the cable glands.
-  For the intended use it is not permitted to operate without the housing cover closed.

3 Operating instructions

3.1 System configurations

Diverse components are necessary for the different system configurations:

- ① Transmitter
- ② Receiver
- ③ Connector cable, preassembled, between transmitter and receiver, lead lengths selectable, usual lengths are 5 m and 10 m
- ④ Supply and output cable, preassembled, lead lengths selectable, usual lengths are 5 m and 10 m
- ⑤ Distributor box (not contained in the delivery scope)
- ⑥ Optional external power supply and control device with additional preassembled connection cable identically pos. “4”
- ⑦ Connection: voltage supply
- ⑧ Connection: switching output

3.1.1 Overall view 3 part configuration

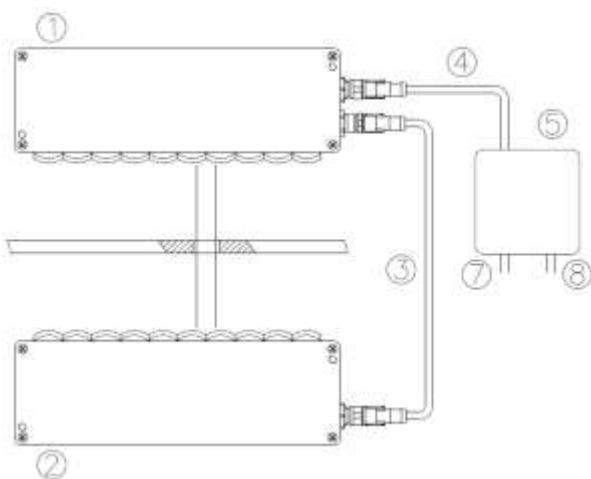

3.1.2 Overall view 4 part configuration

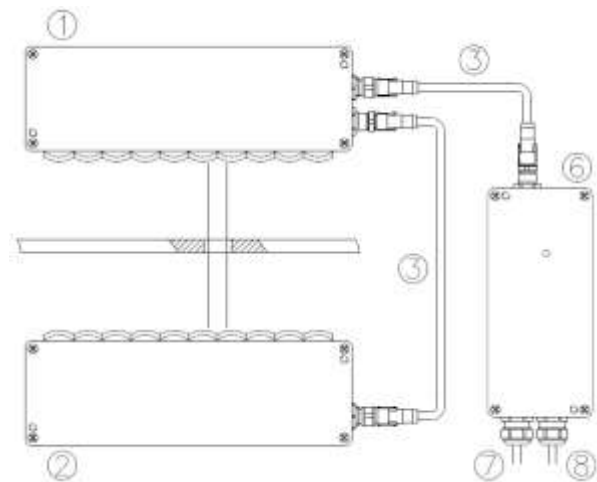

3.2 Operating principle

The hole-detection instruments of the type series PP2445 are intended for the hole-detection in sheet metal. They operate according to the transmitted light principle: light from the transmitter source lights up the receiver positioned opposite by one or more holes in the sheet. In the receiver, a switching signal is created for the duration of the illumination. Via the electrical connecting cable to the transmitter, the status of the switch signal is conveyed to the transmitter, and from there on further to the power supply and control device. Then in the power supply and control device, the specific customer switching output is activated. The switching output of the power supply and control device is to be connected to the process plant control.

The signal function for the customer switching outputs are bright and dark switching. This means: the bright switching output has Function 1 when light illuminates the receiver through a hole, the dark switching output has Function 1, when the sheet clearly interrupts the light contact path between transmitter and receiver.

As a rule, the specific customer switching output of the hole-detection instrument remains activated only for the lighting duration of the receiver. A process plant control, however, can only read the switch status of the hole-detection instrument with discrete time filtering. For this reason, a suitable pulse prolongation – from 0 to 3 seconds, preset to 3 seconds – can be set for the switch status signals of the hole-detection instrument in the transmitter with a potentiometers. For adjusting the pulse prolongation, please read chapter 3.11.

Based on the very impressive optical performance, the hole-detection instruments of the type series PP2445 already work with a simple, directly facing transmitter/receiver configuration.

The distance between transmitter and receiver must be at least up to 4 m.

The detection of holes depends on the hole-size and the strip speed. On choosing the correct instruments, please read chapters 3.4, 3.6 and 4.

3.3 Response behaviour

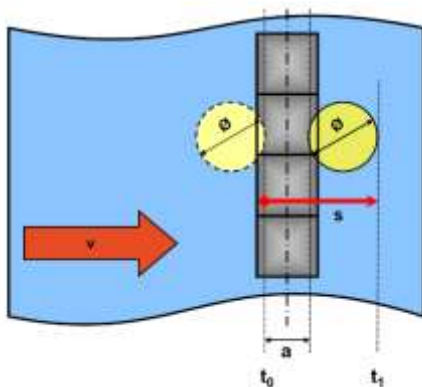

The optical monitoring field of the hole-detection instruments of the type series PP2445 is made up by lining up square lenses with an edge length of ~ 22 mm.

If a hole turns up in the lens row, the illumination of the receiver begins. The illumination ends when the hole leaves the lens row again.

During the illumination $t_1 - t_0$ the hole marking moves on with the specific strip speed v via path s .

If with a known hole size \varnothing and a strip speed v , the condition $s/v = (a + \varnothing)/v = (t_1 - t_0) \geq t_{\text{Access}}$ is fulfilled, the switch output of the hole detector is set.

3.4 Response time characteristics

There are 3 different response time characteristics available:

Response time characteristic and type		Work area	
Standard:	PP2445...	≥ 12 ms/switching transition	—
Option 'q':	PP2445... q	≥ 1,5 ms/switching transition	—
Option 'qq':	PP2445... qq	≥ 0,5 ms/switching transition	—

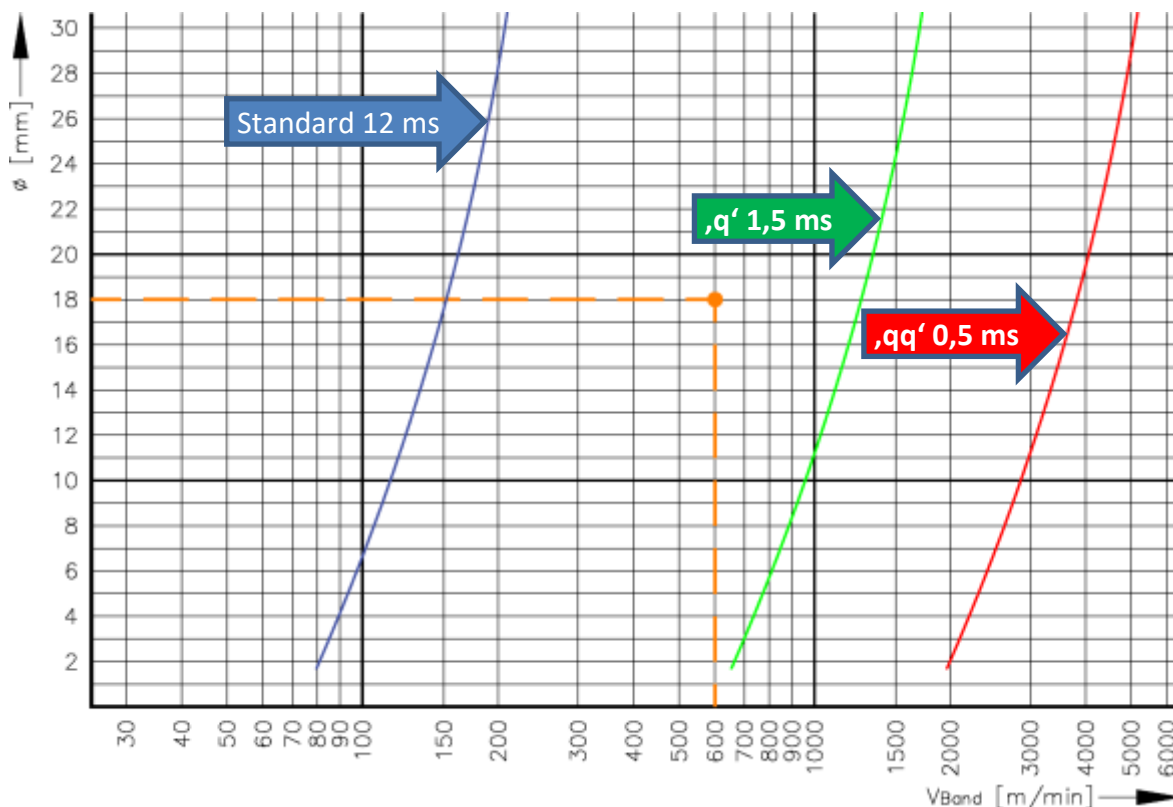

Diagram: Hole-size versus strip speed

Determining the necessary response time characteristic for a specific case of application is determined by the size of the hole marking 'Ø' and the strip speed.



3.5 Determination of the necessary response time characteristic for a specific case of application

For a known hole size and a known strip speed, the coordinate intersection is entered in the diagram: 'Hole-size versus strip speed'. A hole-detection instrument with a response time characteristic is to be selected for which the ascertained coordinate is left of a working area curve.

Example:

Hole marking, diameter 18 mm; strip speed 600 m/min;

The coordinate intersection is left of the green working area curve;

This means that a hole detection instrument with an access time characteristic 'q' is needed.

3.6 Monitoring widths of hole detection instruments

The correct choice of the response time characteristic ensures that with a given hole-size and strip speed, the hole is seen and reported.

However, detecting holes only works if the holes are also run procedurally through the monitoring area of the hole-detector.

For the various applications, hole detection instruments are available both with standardized as also for specific customer monitoring widths. As a reminder: a monitoring width is formed by the lining up of several square lenses with an edge length of ~ 22 mm. The following standard and customer specific hole-detection instruments can be deferred from this.

Monitoring width H [mm] / number of lenses		Status	Response time characteristic		
			Standard	Option 'q'	Option 'qq'
88	4	Standard	PP2445/88	PP2445/88 ...q	PP2445/88 ...qq
154	7	Standard	PP2445/154	PP2445/154 ...q	PP2445/154 ...qq
220	10	Standard	PP2445/220	PP2445/220 ...q	PP2445/220 ...qq
308	14	Standard	PP2445/308	PP2445/308 ...q	PP2445/308 ...qq
≥ 330	≥ 15	Customer specific	PP2445/H	PP2445/H ...q	PP2445/H ...qq
≤ 1980	≤ 90	Customer specific	PP2445/H	PP2445/H ...q	PP2445/H ...qq



3.6.1 Determination of the monitoring width for a hole-detection instrument to find a hole marked welded /basted seam.

To be considered for determining the necessary monitoring width are:

	Example	
1. How big is the side punch tolerance for the hole marking on the welded /basted seam?	± 50 mm	Absolute: 100 mm
2. Which side strip movement tolerance is to be expected?	± 55 mm	Absolute: 110 mm
3. Which various strip ranges are processed on the conveyor system?	Min: 900 mm Max: 1,300 mm	

The absolute sum from the punch tolerance and the strip movement tolerance results in the minimal monitoring width for a hole-detection instrument. Thus, selected is the next bigger standard or specific customer monitoring width as nominal monitoring width.

	The result of the example is:
Minimal monitoring width	210 mm
Nominal monitoring width	220 mm
Inspect: overhang of the monitoring width for narrowest sheets	$55 \text{ mm} \ll (900 \text{ mm} - 220 \text{ mm}) / 2 = 340 \text{ mm}$

After determining the nominal monitoring width, inspection now has to be carried out for the minimal range, so that the hole-detector cannot pass the strip edge also with the side strip movement tolerance of the monitoring area.

3.6.2 Determination of the monitoring width for a hole detection instrument for finding imperfections

To ascertain a hole-detection instrument for finding imperfections, the sheet width, the side strip movement tolerance and the strip speed have to be defined.

3.7 Installation recommendations and presets

3.7.1 General arrangement

- ① Transmitter unit
- ② Receiver unit
- ③ Sheet with hole-marking
- ④ Connecting plug stLU5 (male in unit)
- ⑤ Connecting plug stLU5 (female in unit)
- ⑥ Connecting plug stLU5 (male in unit)

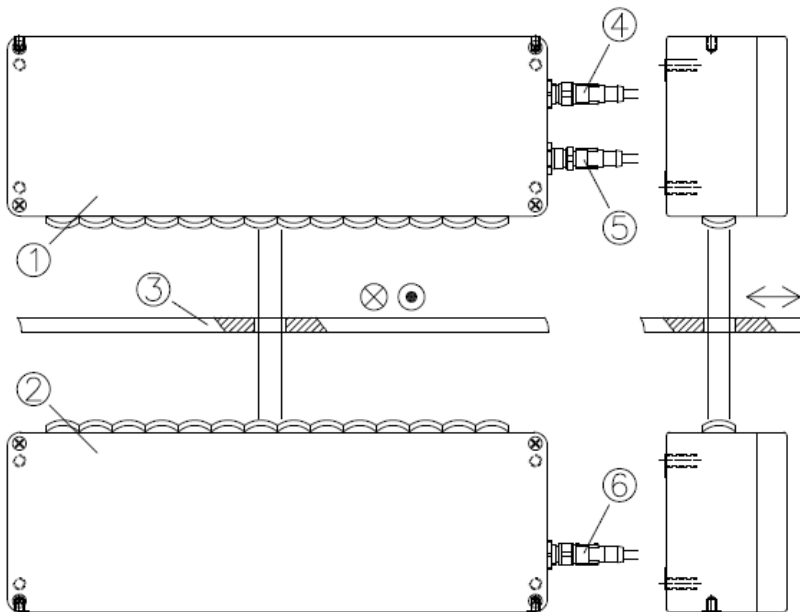

3.7.2 Installation arrangement

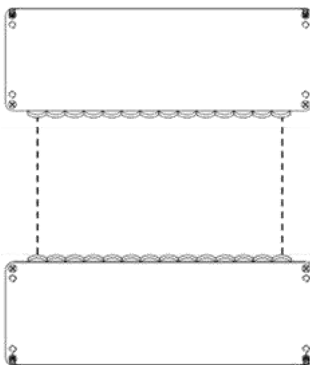

Transmitter and receiver are to be installed facing each other.
 The distance between transmitter and receiver can be up to 4 m.
 The horizontal and vertical alignment tolerance is to be ≤ 3 mm.
 The lens surfaces of transmitter and receiver should face each other plane parallel.

3.7.3 Side floor assembly – from inside

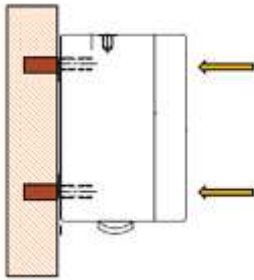

Screws 2x M4, if PP2445/88, .../154 or.../220; 4 x M6, if PP2445/308
 Use of the inner casing through holes
 Threaded blind holes or through holes in the mounting frame

3.7.4 Side floor assembly – from outside

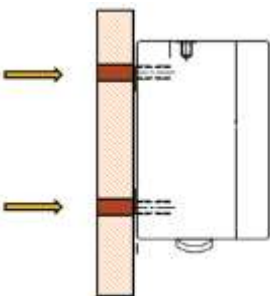

Screws 2x M6, if PP2445/88, .../154 or.../220; 4 x M8, if PP2445/308
 Assembly from outside
 Through holes in the installation plate
 Threaded holes in the casing bottom

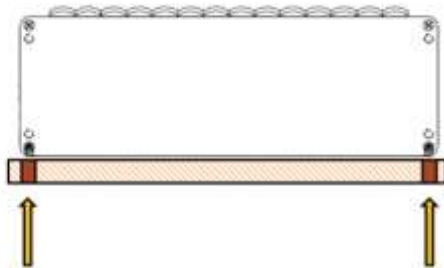

3.7.5 Rear panel assembly – from outside







Screws 2x M6, if PP2445/88, .../154, .../220 or .../308;
 8 x M5, if PP2445/H
 Assembly from outside
 Through holes in the installation plate
 Threaded blind holes in the casing wall

3.8 Electric connection

3.8.1 General information / prerequisites

-  Installation and connection work on the components of the hole-detection instruments must only be carried out in switched off condition.
-  Type and highest rating of the external short-circuit protection devices:

Supply:	2A
PNP Output:	Utilization categories DC-1; DC-13: 60mA
Relay Output:	Utilization categories AC-1; DC-1; DC-13: 6A Utilization category AC-15: 2A
Triggering characteristic:	Circuit breaker: B or C Fuse: slow
-  The relay contacts are to be operated with a minimum current of 20mA.
-  In switching inductive loads, e.g. relay or contactor, with the relay contacts quenching elements are to be switched directly parallel to the inductive load.
 - Switching voltage AC: quenching with an RC element
 - Switching voltage DC: quenching with a freewheeling diode
-  A protective conductor terminal is absolutely necessary for protection from electric shock by exposed conductive parts.
-  The PNP transistor outputs (option: 'e2') are current-limited (60mA) and short circuit proof. Output voltage: high state ~ 22V, low state = open

In the low state, the corresponding PLC input is to be pulled to reference potential OV with a suitable measure, e.g. a pull down resistor.
-  The optoelectronic coupler output is to be connected as NPN transistor. The collector and emitter of this transistor are potential free, and have to be supplied for an electronic function from outside with the supply voltage of the downstream control circuit.

3.8.2 Connection with connector ‘stLU5’

<input type="checkbox"/> PP2445/88S	<input type="checkbox"/> PP2445/220S	<input type="checkbox"/> PP2445/H S
<input type="checkbox"/> PP2445/154S	<input type="checkbox"/> PP2445/308S	

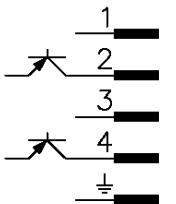
Connection diagram	Pin stLU5	Conductor color code	Description
	1	BN (brown)	+24VDC
	2	WH (white)	PNP open collector dark switching
	3	BU (blue)	0V
	4	BK (black)	PNP open collector bright switching
	PE	GNYE (green/yellow)	protective earth

3.8.3 Supply and output cable transmitter

<input type="checkbox"/> PP2445CC1 /5m /1stLU5	<input type="checkbox"/> PP2445CC1 /10m /1stLU5
--	---

		Transmitter unit	Distributor box (provided by the customer)
	Device connector	stLU5 male	-
	Cable connector	stLU5 female	-
Function	Pin no.	Wire color	Wire color
24VDC	1	Brown	Brown
Signal: PNP open collector, dark switching	2	White	White
0V	3	Blue	Blue
Signal: PNP open collector, bright switching	4	Black	Black
PE	PE	Green/Yellow	Green/Yellow

3.8.4 Connector cable transmitter ↔ receiver

<input type="checkbox"/> PP2445CC2 /5m /2stLU5	<input type="checkbox"/> PP2445CC2 /10m /2stLU5
--	---

		Receiver unit	Transmitter unit
C	Device connector	stLU5 male	stLU5 female
	Cable connector	stLU5 female	stLU5 male
Function	Pin no.	Wire color	Wire color
24VDC'	1	Brown	Brown
nc.	2	White	White
0V'	3	Blue	Blue
Signal: PNP open collector	4	Black	Black
PE	PE	Green/Yellow	Green/Yellow

3.8.5 Connector cable transmitter ↔ power supply and control device (optional)

<input type="checkbox"/> PP2445CC2 /5m /2stLU5	<input type="checkbox"/> PP2445CC2 /10m /2stLU5
--	---

		Receiver unit	Power supply and control device (optional)	
	Device connector	stLU5 male	stLU5 female	
	Cable connector	stLU5 female	stLU5 male	
Function	Pin no.	Wire color	Wire color	Terminal block
24VDC	1	Brown	Brown	22
Signal: PNP open collector, dark switching	2	White	White	nc.
0V	3	Blue	Blue	23
Signal: PNP open collector, bright switching	4	Black	Black	21
PE	PE	Green/Yellow	Green/Yellow	PE

3.8.6 Connection with a terminal block (optional power supply and control device)

 The terminal block described are in the optional power supply and control device.

 Conductor cross section minimum: 0.25 mm² / AWG24
 Conductor cross section maximum: 2.5 mm² / AWG14

3.8.6.1 AC variants – instrument types and option identifications

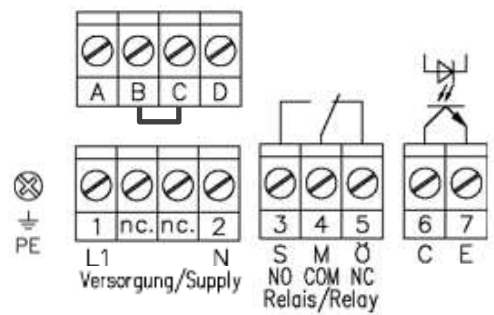
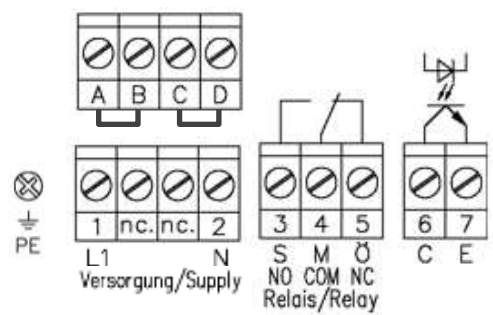
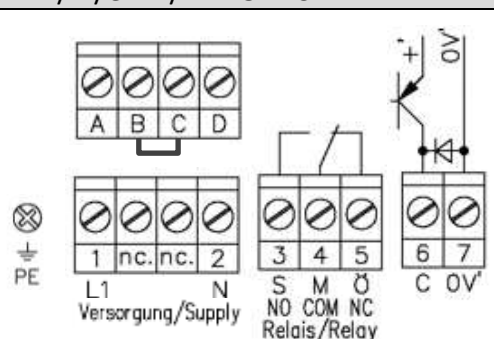
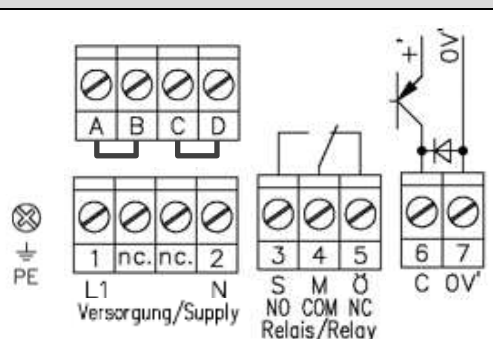
<input type="checkbox"/> PP83201/2	
<input type="checkbox"/> .. /R /e1 .. /230VAC <input type="checkbox"/> .. /R /e1 .. /42-48VAC	<input type="checkbox"/> .. /R /e1 .. /115VAC
	
<input type="checkbox"/> .. /R /e2 .. /230VAC <input type="checkbox"/> .. /R /e2 .. /42-48VAC	<input type="checkbox"/> .. /R /e2 .. /115VAC
	

PP85301 PP86301

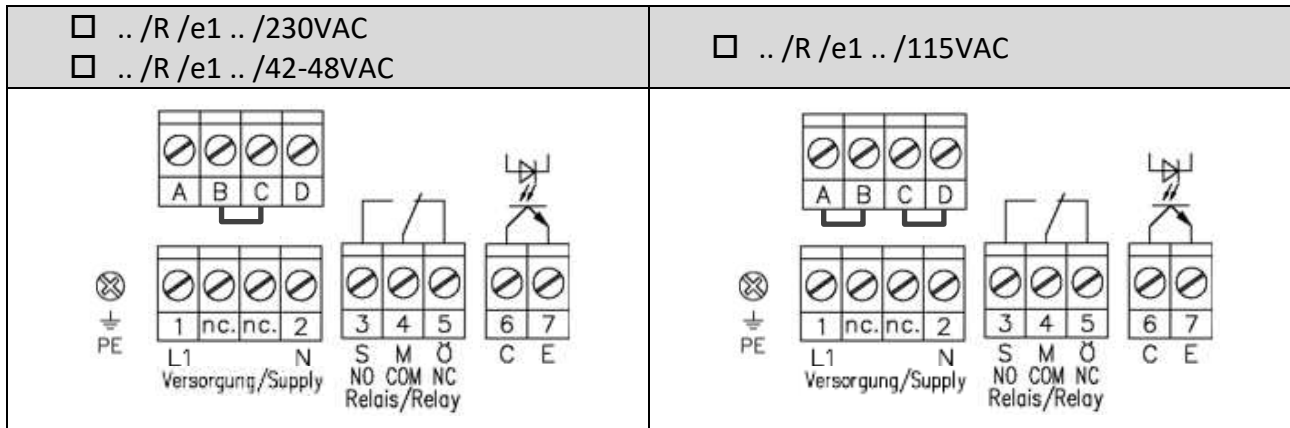

PP83201/2U

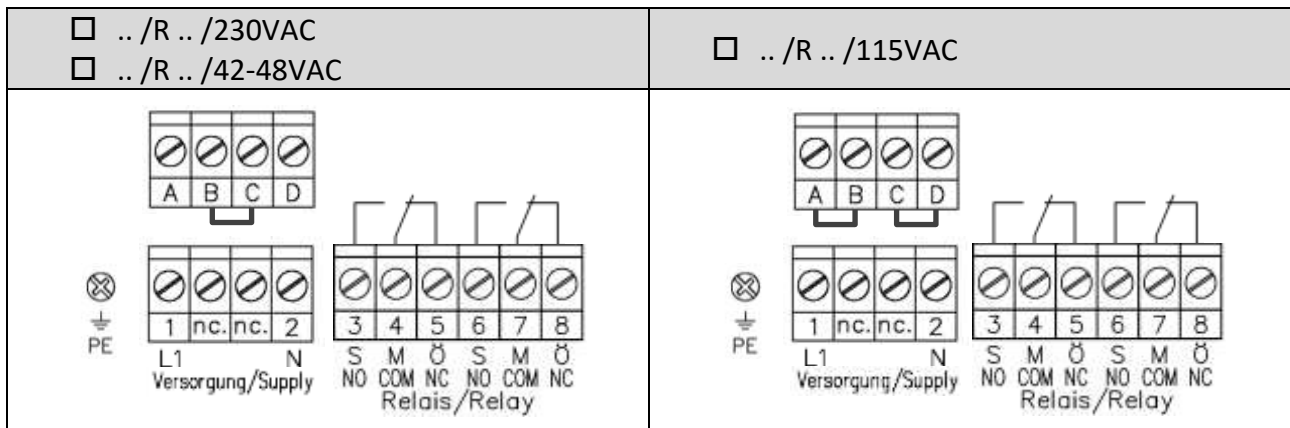

3.8.6.2 DC-Variants – instrument types and option identifications

PP83201/2

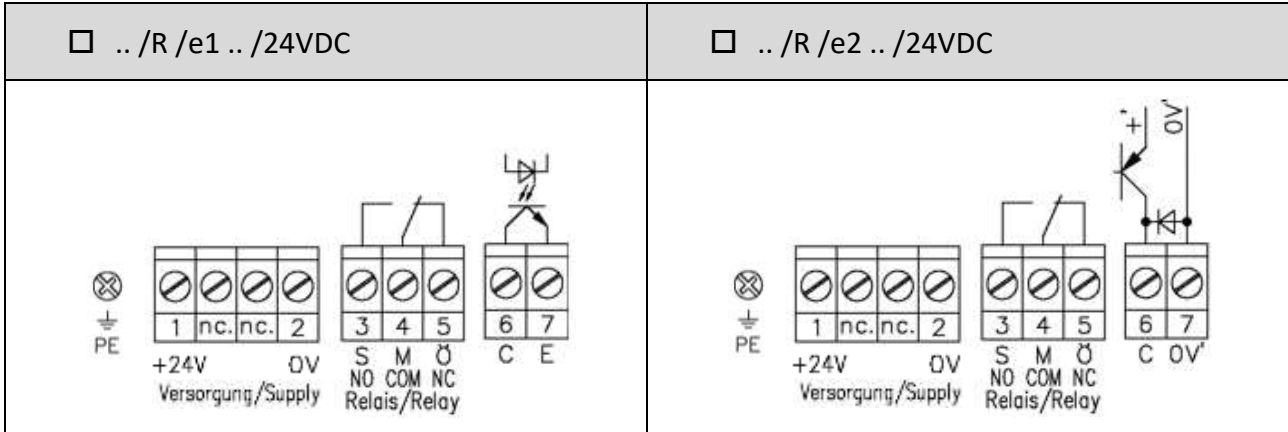

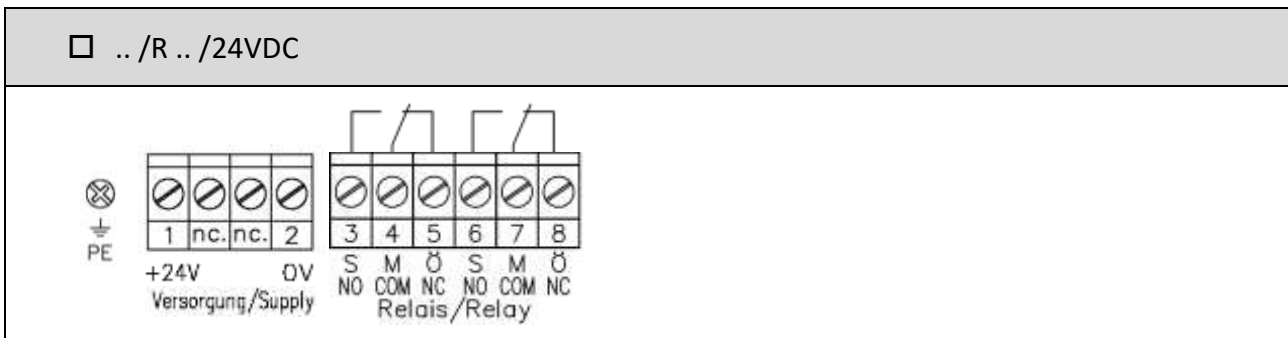

PP83201/2U





3.9 Operator control and indicating elements (overall view)

3.9.1 Transmitter and receiver unit

Symbol	Operator control and indicating element	Device
LED 	Switch indicator LED red LED on = hole LED off = sheet	PP2445 ...S
LED 	Operating indicator LED green LED on = in operation LED off = non-working	PP2445 ...E
	Potentiometer to prolong the switching pulse with the output switching device. The pulse prolongation can be adjusted infinitely variable in the limits from 0 to 3 s ('z3s'), preset to 1 s. Optionally: 0 to 1 s ('z1s') or 0 to 10 s (',z10s').	PP2445 ...S

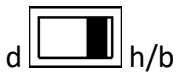
3.9.1 Power supply and control device (optional)

Symbol	Operator control and indicating element	Device
<p>LED</p> 	<p>Switch indicator LED red</p> <p>The display depends on the chosen operating mode:</p> <p>Bright switching LED on = hole LED off = sheet</p> <p>Dark switching LED on = sheet LED off = hole</p>	
	<p>Operating mode switch (b/d switch)</p> <p>b = bright switching</p> <p>d = dark switching</p> <p>Default setting: Operating mode = bright switching</p>	PP83201/2 PP83201/2U PP85301 PP86301
	<p>Potentiometer to prolong the switching pulse with the output switching device. The pulse prolongation can be adjusted infinitely variable in the limits from 0 to 3 s ('z3s'), or optionally from 0 to 1 s ('z1s') or 0 to 10 s (,z10s').</p> <p>The respective potentiometer adjustment for the pulse prolongation time is dependent on the chosen operating mode: bright or dark switching.</p>	
	Mode	Potentiometer
	Bright switching	Ton = 0 s ! Toff = 0 to 3 s
	Dark switching	Ton = 0 to 3 s Toff = 0 s !

3.10 Operating mode switch, switch display and switching output

The output to be used depends on signal processing in the subordinate PLC.

The output “bright switching” is to be used, if a logical 1 signal for the hole event and a logical 0 signal for the covered event (sheet without hole, thus receiver sees no light) is expected in the PLC.

The output “dark switching” is to be used, if a logical 1 signal in the PLC is expected for the covered event (sheet without hole, thus receiver does not see any light) and a logical 0 signal for the hole.

The following table explains the connections between output, event, significance in the PLC, and the relevant switch display.

Output	Event	PLC	LED red	PNP
Bright switching	Hole	1 signal	On	+ UB
	Covered = sheet	0 signal	Off	Output ‘open’
Dark switching	Hole	0 signal	On	Output ‘open’
	Covered = sheet	1 signal	Off	+ UB

For using the respective switch outputs, the advice in chapter: Electric connection is to be heeded.

3.11 Adjustment of the switching pulse prolongation

3.11.1 Pulse prolongation at the bright switching output

The receiver is lighted up by the light of the transmitter through a hole and the switch output remains switched on without adjusted pulse prolongation only for the duration of the illumination. By way of a temporal stage, the duty cycle of the switch output can be appropriately prolonged (preset: 1 s), so that a subsequent evaluation logic can surely process the switching pulse.

For the adjustment the following steps must be carried out.

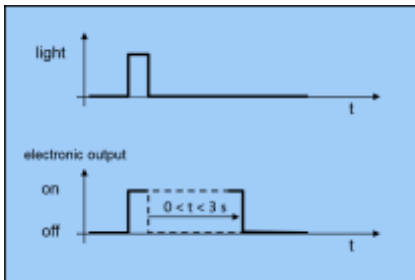

1. First set the potentiometer in minimum position (turn clockwise to stop position position).
2. After that set a time between 0 and 3 s on the potentiometer. Do this by turning the potentiometer anticlockwise to the desired position.

3.11.2 Pulse prolongation at the dark switching output

The switching output is standardly switched on. If the receiver is illuminated by a hole from the light of the transmitter, the switch output is switched off. The switch output remains switched off without adjusted pulse prolongation for the duration of the illumination. By way of a temporal stage, the turn off duration of the switching output can be appropriately prolonged (preset: 1 s), so that a subsequent evaluation logic can surely process the switching pulse.

For the adjustment the following steps must be carried out.

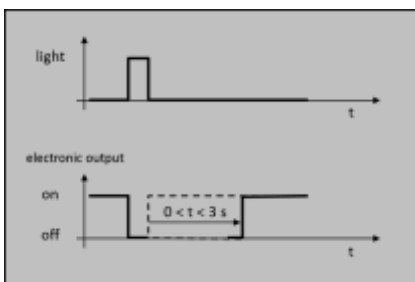

1. First set the potentiometer in minimum position (turn clockwise to stop position)
2. After that set a time between 0 and 3 s on the potentiometer. Do this by turning the potentiometer anticlockwise to the desired position.

3.12 Avoiding optical disturbances

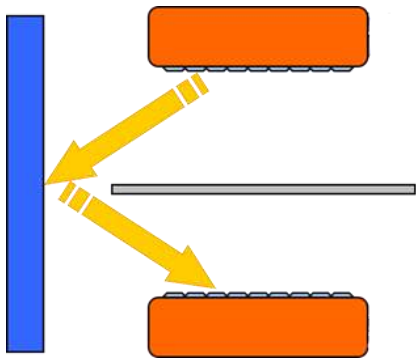

Lighting past the strip edges can cause deficiencies:

1. Allow no direct optical connection between transmitter and receiver past the strip edges.
2. Exclude reflections of the transmitted light over machine elements.

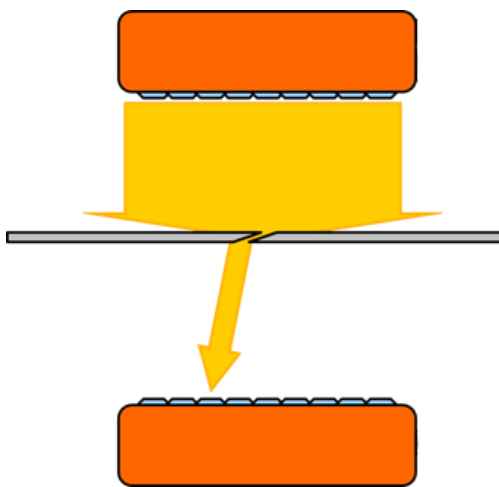

Light pervious places in the sheet, e.g. tears or pin holes can cause welded seam messages.

4 Technical data

4.1 Generally

	Transmitter; Receiver; Control Device
Degree of protection	IP65
Protection class	Class I equipment
Vibration and shock resistance	According to EN 60947-5-2
Pollution degree	4 with mounted housing cover and plugs
Rel. humidity	≤ 90 %
Operating temperature	-25...+60 °C
Storage temperature	-30...+70 °C

4.2 Transmitter units

Hole-detection instrument type PP2445..S (transmitter)	<input type="checkbox"/> .../88	<input type="checkbox"/> .../154	<input type="checkbox"/> .../220	<input type="checkbox"/> .../308	<input type="checkbox"/> .../H (H ≥ 330mm)
<i>Casing</i>	Cast Aluminum				Aluminum
<i>Weight</i>	1,0 kg	1,1 kg	1,25 kg	2,6 kg	~12 kg/m
<i>Connection</i>	Plug connections stLU5				
<i>Voltage supply</i>	24 VDC -10...+20 % ≤ 10 VA				24 VDC -10...+20 % ≤ 528mm: ≤ 10 VA ≤ 704mm: ≤ 30 VA > 704mm: ≤ 60 VA
<i>Switch output</i>					
<i>2x PNP transistor (e4)</i>	DC-1: 60 mA; DC-13: 60 mA; short circuit proof				
<i>Type of signal</i>	Bright and dark switching (antivalent)				
<i>Response time characteristic (turn on & off time)</i>	Recommended working area				
<i>Standard</i>	≥ 12 ms/switching transition				
<i>Quick (option: /q)</i>	≥ 1,5 ms/switching transition				
<i>Very quick (option: /qq)</i>	≥ 0,5 ms/switching transition				
<i>Switching frequency</i>					
<i>Standard</i>	~40 Hz				
<i>Quick (option: /q)</i>	~333 Hz				
<i>Very quick (option: /qq)</i>	~1000 Hz				
<i>Switching pulse prolongation</i>	0 ... 3 s, preset to 1 s				
<i>Working range</i>	0...4 m, operating reserve ≥ 5000				
<i>Light transmission</i>	LED; 850...880 nm (IR-A); invisible				
<i>Interference suppression</i>	Forced synchronization				
<i>Steady light resistance</i>	> 80 kLx				
<i>Switching indicator</i>	LED red				
<i>Operating indicator</i>	LED green				

4.3 Receiver units

Hole-detection instrument type PP2445..E (Receiver)	<input type="checkbox"/> .../88	<input type="checkbox"/> .../154	<input type="checkbox"/> .../220	<input type="checkbox"/> .../308	<input type="checkbox"/> .../H (H ≥ 330mm)
<i>Casing</i>	Cast Aluminum				Aluminum
<i>Weight</i>	0,8 kg	1,1 kg	1,25 kg	2,4 kg	~12 kg/m
<i>Connection</i>	Plug connection stLU5				
<i>Voltage supply</i>	From the corresponding transmitter unit				
<i>Response time characteristic (turn on & off time)</i>	Working area				
<i>Standard</i>	≥ 12 ms/switching transition				
<i>Quick (option: /q)</i>	≥ 1,5 ms/switching transition				
<i>Very quick (option: /qq)</i>	≥ 0,5 ms/switching transition				
<i>Switching frequency</i>					
<i>Standard</i>	~40 Hz				
<i>Quick (option: /q)</i>	~333 Hz				
<i>Very quick (option: /qq)</i>	~1000 Hz				
<i>Signal output</i>	PNP transistor; short circuit proof				
<i>Working range</i>	0...4 m, operating reserve ≥ 5000				
<i>Interference suppression</i>	Forced synchronization				
<i>Steady light resistance</i>	> 80 kLx				
<i>Switching indicator</i>	LED red				
<i>Operating indicator</i>	LED green				



4.4 Power supply and control devices

Power supply and control devices	<input type="checkbox"/> PP83201/2	<input type="checkbox"/> PP85301	<input type="checkbox"/> PP86301	
<i>Monitoring widths of hole detectors</i>	Up to 528 mm	Up to 704 mm	Larger than 704 mm	
<i>Output</i>	10 VA	30 VA	60 VA	
<i>Casing</i>	Cast Aluminum			
<i>Weight</i>	0,8 kg	2,7 kg	2,8 kg	
<i>Connection</i>	Terminal blocks & Plug connection stLU5 & 2x cable gland			
<i>Voltage supply</i>	Options :			
	230 VAC ± 10 %	115 VAC ± 10 %	42...48 VAC ± 10 %	24 VDC -10...+20 % (only PP83201/2)
	AC: 50...60 Hz			
<i>Switch output</i>				
<i>Relay (option /R)</i>	1x Changeover AC-1: 6 A / 1500 VA @ 250 VAC AC-15: 2 A / 500 VA @ 230 VAC DC-1: 6 A @ 30 VDC DC-13: 6 A @ 30 VDC (AC-15 or DC-13: snubber wired in parallel with the load required)			
<i>PNP transistor (option: /e2)</i>	DC-1: 60 mA DC-13: 60 mA short circuit proof			
<i>Optocoupler (option: /e1)</i>	DC-1: 50 mA @ 60 VDC DC-13: 50 mA @ 60 VDC short circuit proof			
<i>Type of signal</i>	Bright /dark switching (optional)			
<i>Frequency of operating cycles</i>	Relay	Electronic		
<i>Standard</i>	10 Hz	40 Hz		
<i>Quick (option: /q)</i>	10 Hz	333 Hz		
<i>Very quick (option: /qq)</i>	10 Hz	1000 Hz		
<i>Time delay</i>	0 to 3 s; switch-on and off delayed; separately adjustable			
<i>Switching display</i>	LED red			

5 Dimensions

5.1 Hole detection instruments with monitoring width of 88 mm to 220 mm

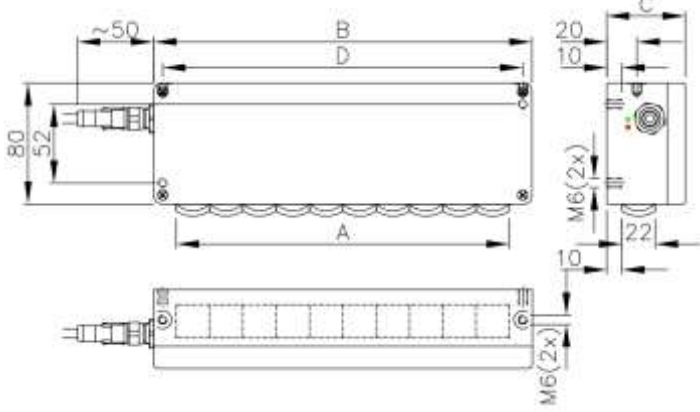
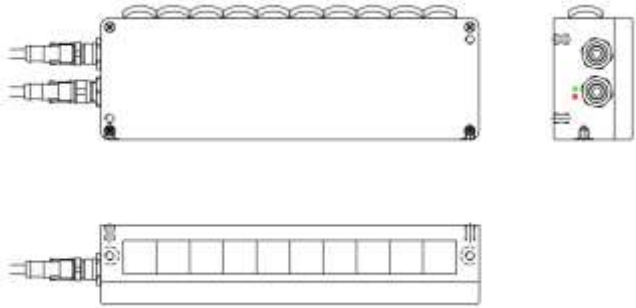
Receiver	<input type="checkbox"/> PP2445/88E <input type="checkbox"/> PP2445/154E <input type="checkbox"/> PP2445/220E	
Transmitter	<input type="checkbox"/> PP2445/88S <input type="checkbox"/> PP2445/154S <input type="checkbox"/> PP2445/220S	

Type	Dimension "A"	Dimension "B"	Dimension "C"	Dimension "D"	Number of optics
PP2445/88	88	125	57	113	4 each
PP2445/154	154	175	57	163	7 each
PP2445/220	220	250	52	238	10 each

5.2 Hole detection instruments with monitoring width 308 mm

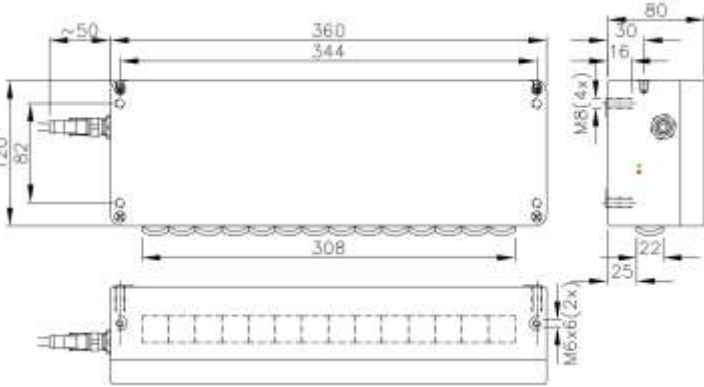
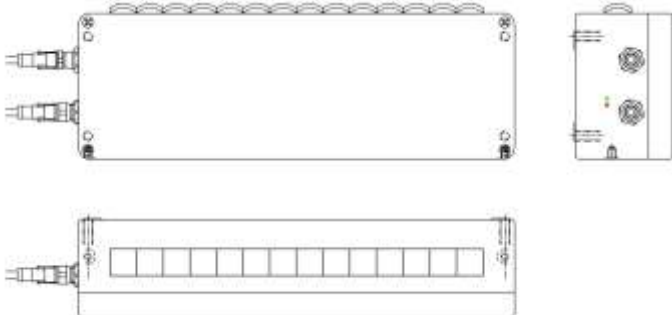
Receiver	<input type="checkbox"/> PP2445/308E	
Transmitter	<input type="checkbox"/> PP2445/308S	

5.3 Hole detection instruments with application specific monitoring widths larger than 308 mm to 1980 mm

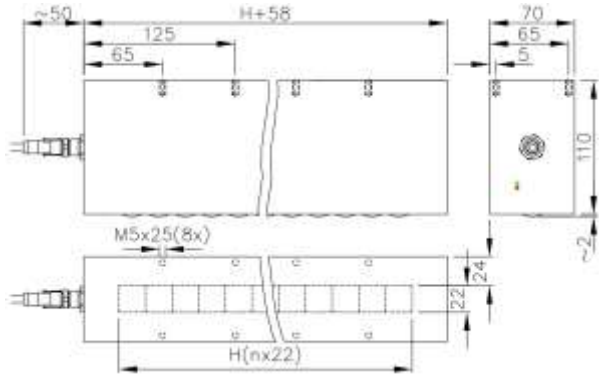
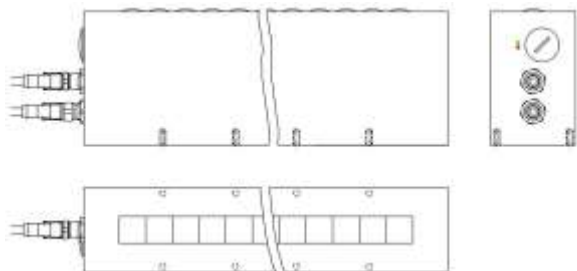
Receiver	<input type="checkbox"/> PP2445/H E	
Transmitter	<input type="checkbox"/> PP2445/H S	

5.4 Power supply and control device

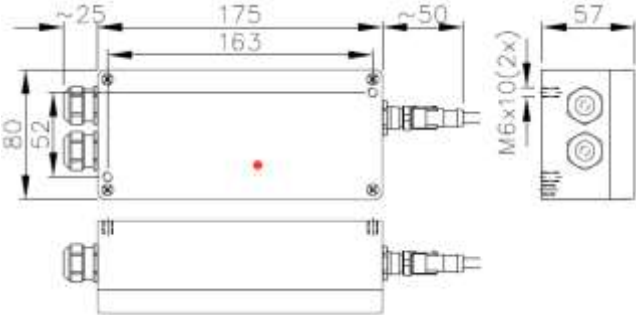
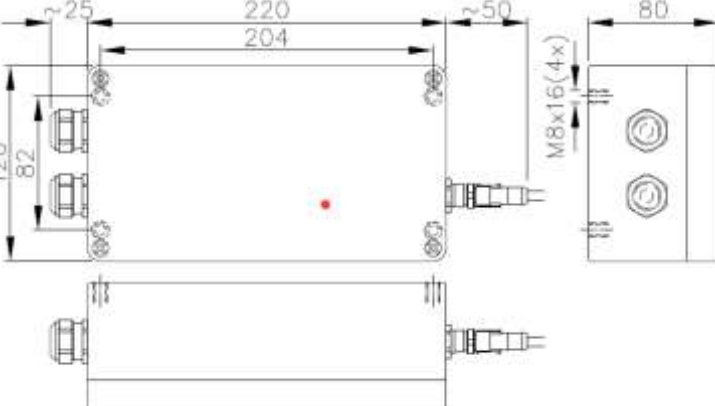
Power supply and control devices	<input type="checkbox"/> PP83201/2	
	<input type="checkbox"/> PP85301 <input type="checkbox"/> PP86301	

6 Document collection

Serial number	Type	Description	Document
2420	PP83201/2	Data sheet	E_24201.pdf
2433	PP84201/2	Data sheet	E_24201.pdf
2435	PP85301	Data sheet	E_24351.pdf
2436	PP86301	Data sheet	E_24361.pdf
4351	PP2445/88	Data sheet	E_43511.pdf
4352	PP2445/154	Data sheet	E_43521.pdf
4353	PP2445/220	Data sheet	E_43531.pdf
4354	PP2445/308	Data sheet	E_43541.pdf
4355	PP2445/H	Data sheet	E_43551.pdf
4351...4355	PP2445...	Operating instructions (this document)	E_435x2.pdf

7 Maintenance and cleaning

-  The cleaning of the optical surfaces and the testing of the functions must only be carried out by competent specialist personnel.

Depending on the dust accumulation in the company, the optical surfaces of the hole-detection instruments are to be cleaned in suitable time intervals.

For cleaning the optical surfaces, a soft lint-free cloth moistened with water is to be used. If necessary, a very small amount of a customary washing up liquid can be added to the cleaning water.

-  Don't use any cleansing agents which contain alcohol or solvents.

-  Don't scratch the optical surfaces.

8 Taking out of service

The equipment has to be disposed of appropriately after the expiry of its service life. In taking out of service, observe the local laws on disposal of electronic equipment.

9 Spare parts

On request.

PDF: E_435x2.pdf

SRC: E_435x2_2020-04.docx

Date: 2020-08-04 tb

Design and make of the devices and their electronics are the intellectual property of FOTOELEKTRIK PAULY GmbH. Technical changes and mistakes are reserved. The reprinting of this operating instruction or the copying of extracts from it are allowed only with the approval of the FOTOELEKTRIK PAULY GmbH and with source citation.